

Chapter 4

Dish Antenna Installation

These instructions guide you through the installation of a satellite system which includes your receiver (included with this manual), and a DISH Pro DISH 500 antenna system that can be identified by the DISH Pro logo shown below.



Installing a DISH 500 Antenna

The first step in installing your dish antenna is to assemble the satellite dish, mount it, and point it in the general direction of a satellite. To do this, follow these instructions:

Finding the Satellites

You need to find the satellites in the sky. To do this, you need to know the azimuth angle (the south, southeast, or southwest direction to the satellites) and the elevation angle (the angle up to the satellites) from your location, and the skew angle.

1. Make sure that the batteries are fresh in both remote controls, and are installed properly. If needed, make sure that the remote is in **SAT** mode to control the satellite receiver.
2. Make sure your satellite receiver is connected to your TV(s) and confirm that the remote controls are controlling the menus properly using the instructions in *Chapter 2*. Turn ON the television and receiver.
3. Display the **Point Dish** menu on the nearby TV by pressing **MENU** and then **6-1-1** using Remote Control 1 (unless your TV already displays this menu).

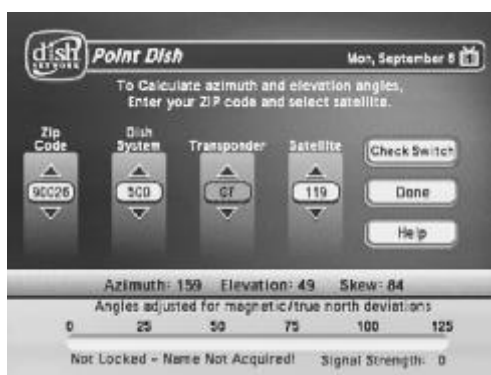

Dish Antenna Installation

4. Enter your ZIP code in the **ZIP Code** field.
5. Make sure that **500** is shown under **Dish System**.
6. The menu displays the azimuth, elevation, and skew angles. Write down these numbers in the blanks provided in the margin.

Mounting the Dish

1. Using the azimuth and elevation angles, find a location for the satellite dish which can be pointed towards the satellites located at these angles. With a compass, find the required azimuth angle. Then, use the elevation angle to find out how high the satellites are in the sky from your location.

Make sure nothing blocks the line of sight between the dish and the satellites.

2. Mount the mast to a solid surface so that the dish antenna cannot move or be bumped out of adjustment. Keep in mind that physical and environmental conditions can block your satellite dish's ability to receive a clear satellite signal. The conditions to be aware of are: Eaves and overhangs on your building or house, wind, plant growth, and deterioration of the mounting surface. Never mount to a tree.

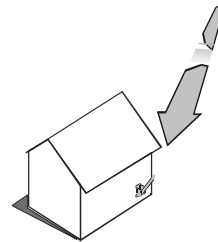

3. Align the top part of the mast so that it is absolutely vertical, as shown below. If the top part of the mast is off vertical by only a few degrees, it will be difficult or maybe even impossible for you to find the satellites. Take at least two readings with a bubble level, on the upper mast, that are 90 degrees apart from one another.

4. Assemble the satellite dish as shown below, except do not attach the Y-bracket or LNBF at this time.

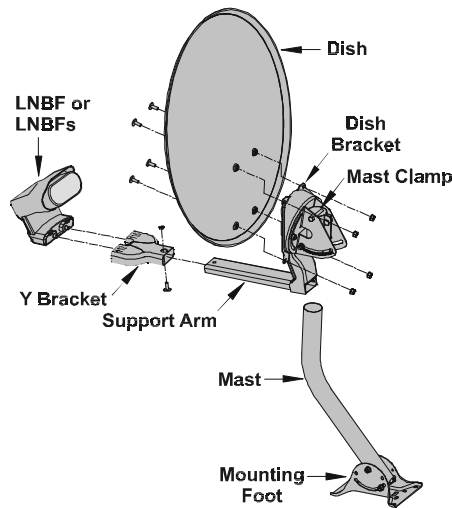

5. Loosen both skew bolts and set the skew by rotating the dish mounting bracket to align the red mark with the required angle on the skew scale which you wrote down on page 92. Tighten the skew bolts securely to keep the dish from rotating. **Once the skew is set, do not try to fine-tune this angle when aiming the dish.**

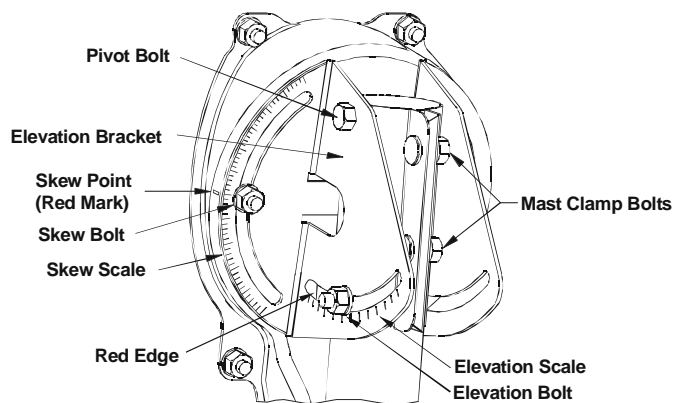

6. Set the elevation by tilting the dish mounting bracket to align the red edge with the required angle from page 92 on the elevation scale. Tighten the elevation bolts, but *do not* tighten the pivot bolt at this time.
7. Slide the dish assembly down onto the mast. Make sure the pivot bolt rests on the top of the mast. Turn the dish assembly so that it points in the general direction of the satellites, using the azimuth angle from page 92.
8. Thread two RG-6 coaxial cables through the mast, support arm, and the Y-bracket. These cables should be long enough to run from your receiver to your LNBF.

Note: See *Running Coaxial Cables* on page 106 for cable installation guidance.

Dish Antenna Installation

Note: You can have as much as 200 feet of cable between the DISH Pro LNB and the DISH Pro receiver. However, you must use only RG-6 coaxial cables rated for 950 to 2150 MHz. Some cables may say "Swept tested for 2150 MHz." If you have any doubt about this, ask your DISH Network retailer, or look on the container the cable came in. Do not use cable company TV cables or cables from other satellite TV systems not rated for 950-2150 MHz. These other cables may cause signal loss. Do not use existing cables such as RG-59. Also, be sure that any outdoor connections are made using waterproof F-connectors.

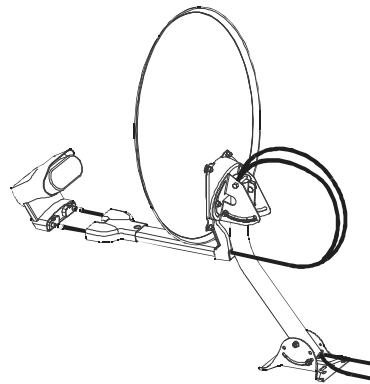

9. Attach the Y-bracket, using the Y-bracket screw.
10. Connect the RG-6 cables from the two **SATELLITE IN** connections on the back of the receiver *directly to the two ports* of the DISH Pro Twin LNB, as shown below. Be sure there are no multi-dish switches between the LNB and the receiver.



Tighten all of the coaxial cable connections *only* by hand. If you use a wrench, you may over-tighten the connections and damage your equipment. Such damage is *not* covered by the limited warranty.

11. Attach the LNB to the Y-bracket using the two LNB screws.
12. You should see the **Point Dish** menu on your nearby TV. If not press **MENU** and then **6-1-1** on Remote Control 1.

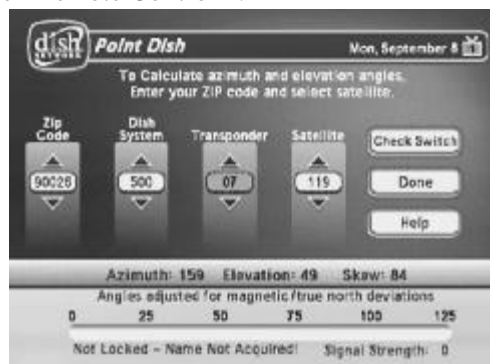

13. Select **Check Switch**. The **Check Switch** screen will open.
14. Select **Retest**. The receiver shows you a message that it is checking the system.

15. When the check switch procedure finishes, you will see an **Installation Summary** screen similar to the one below. The information for **Satellite Input 1** and **Satellite Input 2** should be the same:

- **Satellite - Conn** twice.
- **Transponder - X** twice. This is OK and does not indicate a problem with the receiver.
- **Device Type - Twin** twice. This indicates that your receiver has confirmed the connection with your DISH Pro Twin LNBF is working.

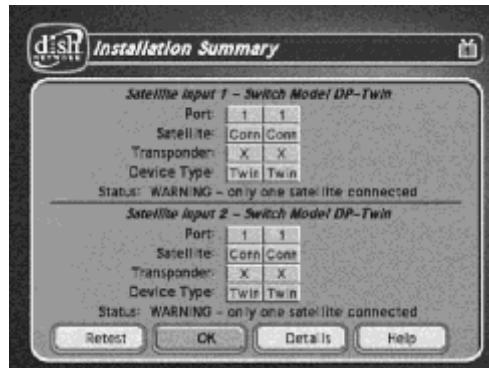

16. Select **OK** to return to the **Point Dish** screen.

17. Make sure the screen shows **119** under **Satellite**. If not, move the highlight to **119** and press either the UP or DOWN ARROW.

Note: The signal strength bar is used to help you aim the dish by showing the strength of the signal you are receiving. Look at the signal strength bar while you aim the dish.

Note: Don't stand in front of the dish while you aim it, because your body will block the satellite signal. After you adjust the aim, let go of the dish so that you can get a good signal reading after the dish settles back in place by itself.

18. Turn the dish back and forth *very slowly*, until the signal strength bar turns *green*. This shows you've found the signal.

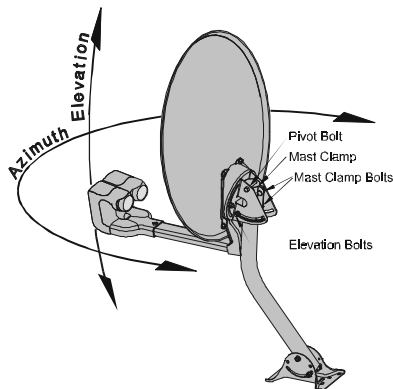

Dish Antenna Installation

Note: If you cannot find the signal, turn the dish back to the first azimuth angle. Then, loosen both elevation bolts *just enough* so you can tilt the dish. Tilt the dish elevation up by two degrees, and then tighten both bolts. Now, turn the dish back and forth again. *If you still can't find the signal*, tilt the dish up again *very slightly* and turn the dish back and forth until you find the signal. **Do not change the skew setting.**

19. When the signal strength bar is *green*, turn the dish back and forth **just a little**, to where the signal strength bar shows the strongest signal. When you find the strongest signal, tighten both mast clamp bolts. Then loosen both elevation bolts, *just enough* so you can tilt the dish. Tilt the dish up and down **just a little**, to where the signal strength bar shows the strongest signal. When you find the strongest signal, tighten all bolts in the dish assembly so the dish cannot be moved.
20. You are now ready to verify reception from both satellites. Select the **Check Switch** option. When the **Check Switch** menu opens, select **Retest**. The receiver shows you a message that it is checking the system. When the procedure is finished, you will see an **Installation Summary** screen. This screen may look different than the one shown below.
 - **Satellite** - 119 in **Port 1** and 110 in **Port 2**.
 - **Transponder** - All twice. This is OK and does not indicate a problem with the receiver.
 - **Device Type** - Twin twice. This indicates that your receiver has confirmed the connection with your DISH Pro Twin LNBF is working. Press OK to exit this menu.”
 - **Status** - Satellite reception verified.

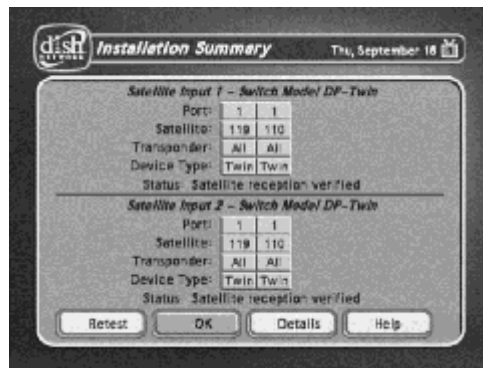

21. If you do not see **110** under **Port 2**:
 - Make sure the skew angle you wrote down on page 92 is exactly the same as the skew angle you set in step 5 on page 93. If it is not, reset the skew angle as described on page 93. After you reset the skew angle, go back page 95 and start over from step 16.
 - If **119** is shown under **Port 2**, move the dish approximately 9° to the east and restart the procedure at step 12.
22. Look at the **Point Dish** menu. If you have good signal strength with **119** s indicated by a green signal bar, select **110**. If you have good signal strength on **110**, go to step 23.

If you do not have good signal strength with **110**, go back to step 18, and fine-tune the dish but with **110** selected instead of **119**. While the **110** and **119** signals will not be equal, you should be able to fine-tune the dish until you have the strongest possible signal from both satellites.

23. Select **Cancel** to exit the **Point Dish** menu. An **Attention** screen will open asking the mounting and positioning of your dish is complete with a **Locked** indication in the **Point Dish** screen. If the answer is yes, select **Yes**.

*If the answer is **No**, you will need to repoint your dish following the preceding steps until the mounting and positioning is complete and you do have the **Locked** indication.*

24. After you select **Yes**, the receiver will begin taking a software upgrade. You will see a **Warning** that **Vital program information will now be downloaded into your receiver**. You will also see a status bar showing the progress of this upgrade.
25. Once the software upgrade is complete, you will see a message that your receiver's memory is being upgraded.

Do not disturb the receiver while the receiver's memory is being upgraded.

26. When the memory upgrade is complete, you should be watching TV. Your dish antenna installation is now complete.

Note: If you are installing other DISH Pro or DISH Pro Plus receivers, be sure to run **Check Switch** on all of them, and allow them to take the necessary software upgrade.

Installing a Multiple Dish DISH Pro System

Note: You cannot use DISH Pro LNBFs and switches (those marked with the DISH Pro logo) with Legacy switches and LNBFs (those without the DISH Pro logo). You must install your DISH antenna system with either all DISH Pro LNBFs and switches or all Legacy LNBFs and switches. If you mix the two, the system will not work.

Note: You can have as much as 200 feet of cable between the DISH Pro LNBF and the DISH Pro receiver. However, you must use only RG-6 coaxial cables rated for 950 to 2150 MHz. Some cables may say "Swept tested for 2150 MHz." If you have any doubt about this, ask your DISH retailer, or look on the container the cable came in. Do not use cable company TV cables or cables from other satellite TV systems not rated for 950-2150 MHz. These other cables may cause signal loss. Do not use existing cables such as RG-59. Also, be sure that any outdoor connections are made using waterproof F-connectors.

Once you have installed the DISH 500 with its DISH Pro Twin LNBF using the preceding instructions, you can add a DISH 300 with a DISH Pro LNBF and switch as follows:

1. Turn on the television and the receiver if they are not already on. You should see the **Point Dish** screen. If not, open the **Main Menu** and press 6-1-1 on the remote.

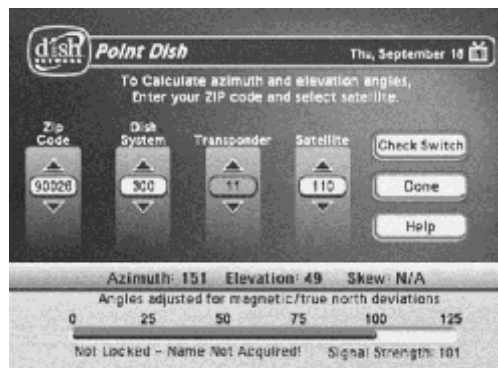

2. Select the satellite your dish will be pointed toward.
3. Select **300** under the **Dish System**.
4. Use the number buttons on the remote to enter your ZIP code to get the necessary azimuth and elevation. Write these numbers down in the spaces provided in the margin.
5. Mount the dish antenna and multi-dish switches following the mounting instructions that came with them and the *DISH Pro Wiring Diagrams* starting on page 100.
6. Connect two RG-6 cables from both **SATELLITE IN** connections on the receiver to two available ports on the switch(es).
7. Connect the LNBF on the DISH 300 to LNBF port 1 on the switch(es) using RG-6 cable.

8. Select **Check Switch** from the **Point Dish** menu. When the **Check Switch** screen opens, select **Retest**.
9. When **Check Switch** is complete, you will see an **Installation Summary** screen similar to the one shown next. It will show a connection (“Conn” next to satellite) and **Single** device under **1** (Dish Input). It may also show an **X** on the Transponder line. This is okay and does not mean there is a problem with the system.



10. Press **CANCEL** to exit back to the **Point Dish** menu.
11. Point the dish for the strongest possible signal, following the instructions that came with it.
12. Connect two RG-6 cables between both ports on your DISH Pro Twin LNBF and your switch(es) using the switch instructions and the *DISH Pro Wiring Diagrams* that start on page 100.
13. Select **Check Switch** from the **Point Dish** menu. When the **Check Switch** menu opens, select **Retest**. When the procedure completes, you will see the **Installation Summary** screen again. This time you should see confirmation for all satellites your dishes are pointed at, and “Satellite reception verified.” You should also see that the switch(es) in your system has been correctly identified.
Refer to the DISH Pro wiring diagrams for examples of installation summary screens.
14. Press **CANCEL** to exit this menu, and then **Done** to exit the **Point Dish** screen. If you have any other receivers in your system, make sure you run **Check Switch** on each of them, and allow each to take the software upgrade, as needed.

DISH Pro Wiring Diagrams

DISH 500, One DISH Pro Twin LNBF



This diagram leaves out grounding to be clear. Make sure you ground the system per the *National Electrical Code* (NEC) and all local electrical codes.

Do not
connect
the
antenna
to
the
receivers
until
after
the
wiring
is
complete.

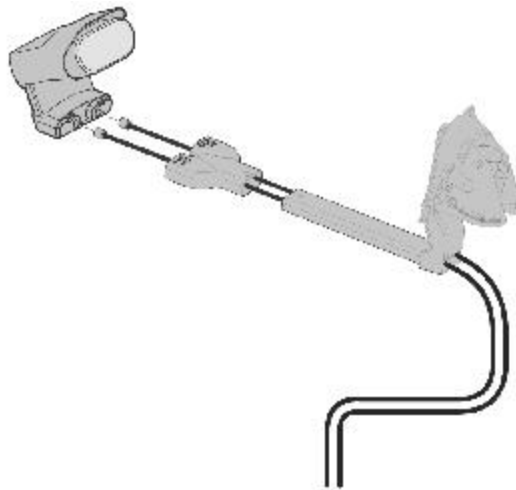

To two DISH Pro
Receivers or one DISH
Pro Plus Receiver

When you set up your system following this diagram and run **Check Switch** the **Installation Summary** screen should look similar to the one shown below.

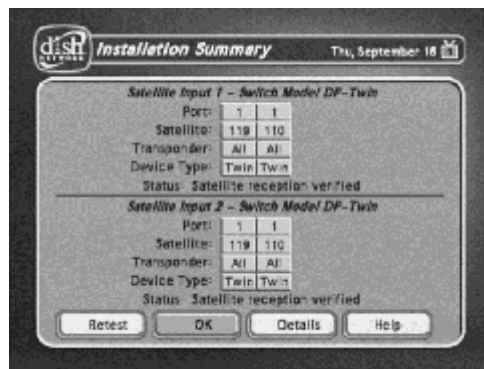

DISH 500, One DISH Pro Quad LNBF



This diagram leaves out grounding to be clear. Make sure you ground the system per the *National Electrical Code* (NEC) and all local electrical codes.

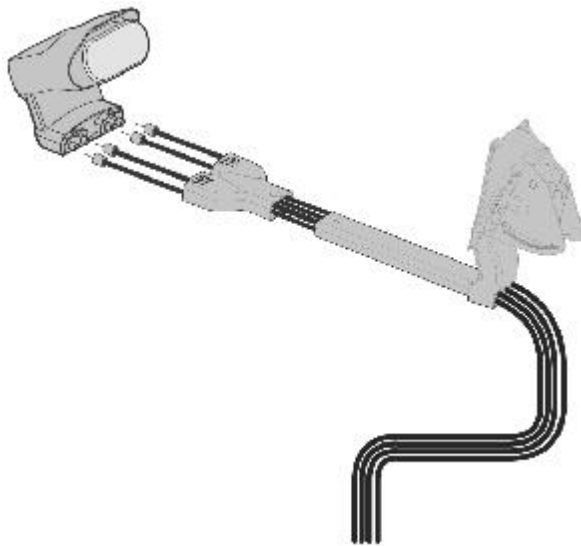

To four DISH Pro
Receivers or two DISH
Pro Plus Receivers

When you set up your system following this diagram and run **Check Switch** the **Installation Summary** screen should look similar to the one shown below.

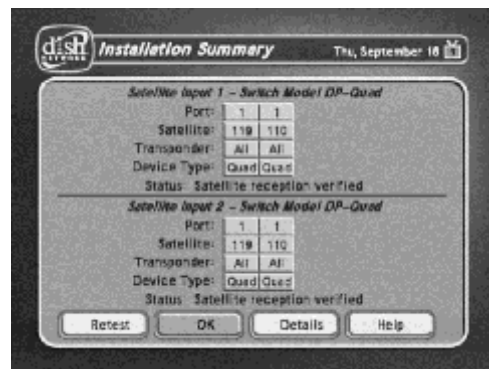

DISH 500 with a DISH Pro Twin LNBF, One DISH 300 with a DISH Pro LNBF, DP34 Switch



This diagram leaves out grounding to be clear. Make sure you ground the system per the *National Electrical Code* (NEC) and all local electrical codes.

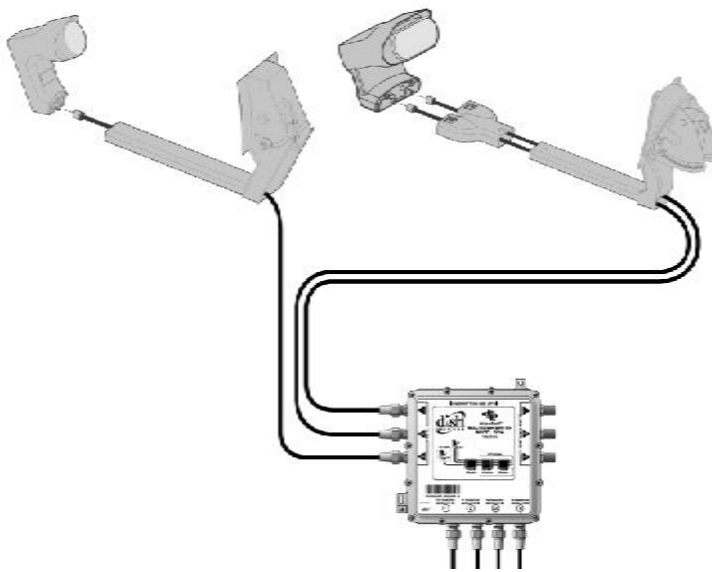

To four DISH Pro Receivers or two DISH Pro Plus Receivers

When you set up your system following this diagram and run **Check Switch** the **Installation Summary** screen should look similar to the one shown below.

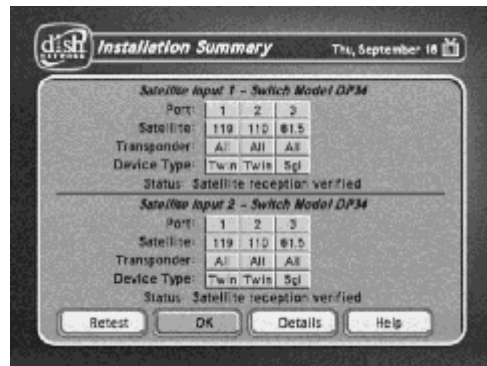

DISH 500, DISH 300, Three DISH Pro LNBFs, DP34 Switch



This diagram leaves out grounding to be clear. Make sure you ground the system per the *National Electrical Code* (NEC) and all local electrical codes.

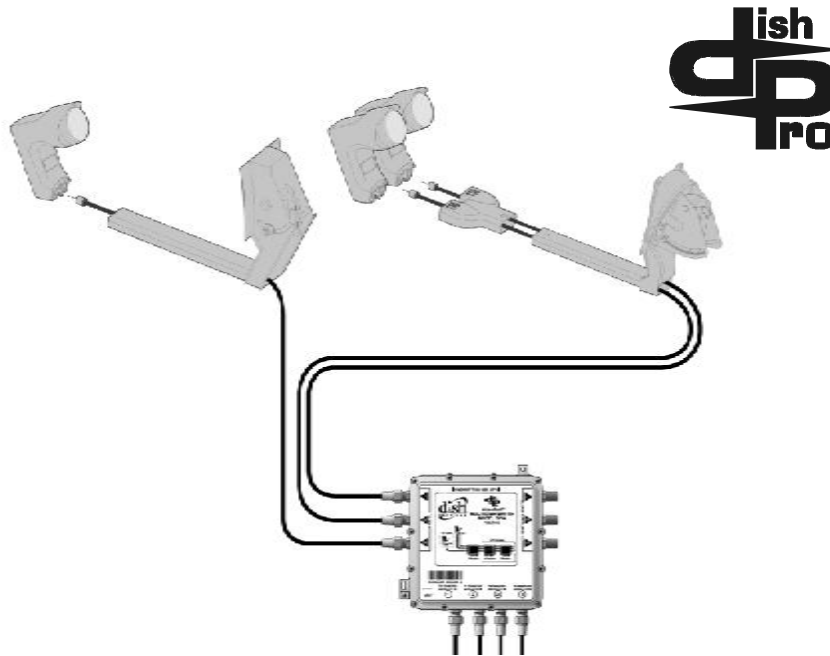

To four DISH Pro Receivers or two DISH Pro Plus Receivers

When you set up your system following this diagram and run **Check Switch** the **Installation Summary** screen should look similar to the one shown below.

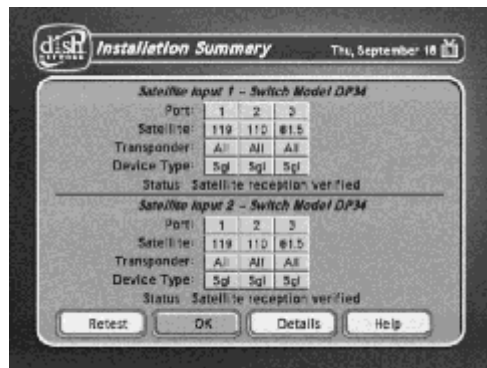

Dish Antenna Installation

DISH 500, DISH 300, One DISH Pro Twin LNBF, One DISH Pro Single LNBF, One DISH Pro Compliant Splitter, Two DISH Pro 21 Switches



This diagram leaves out grounding to be clear. Make sure you ground the system per the *National Electrical Code* (NEC) and all local electrical codes.



* When using a DISH Pro compliant splitter to split the signal from a DISH Pro single LNBF, the receiver tuner whose DP21 switch is connected to the passing side of the splitter must be plugged into a live power outlet at all times. If not, the DISH Pro single LNBF will not have any power and will not be able to provide satellite signal to the other receiver tuner.

When you set up your system following this diagram and run **Check Switch** the **Installation Summary** screen should look similar to the one shown below.

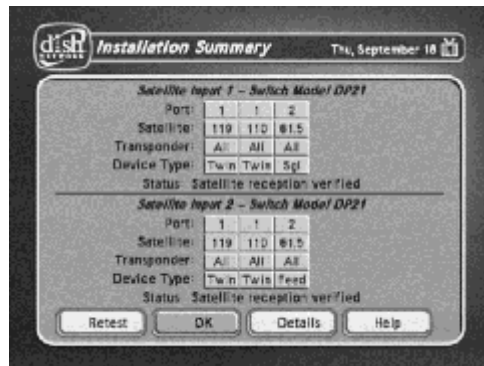

Two DISH 300s, Two DISH Pro Single LNBFs, Two DISH Pro Compliant Splitters, Two DISH Pro 21 Switches



This diagram leaves out grounding to be clear. Make sure you ground the system per the *National Electrical Code* (NEC) and all local electrical codes.

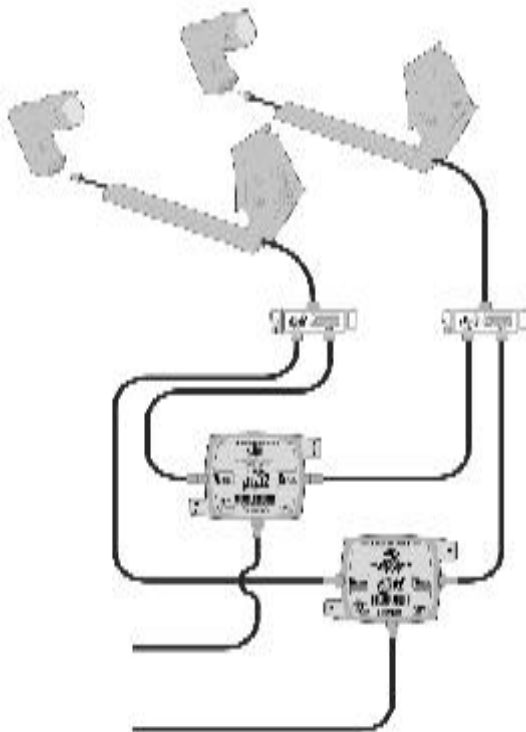

* When using a DISH Pro compliant splitter to split the signal from a DISH Pro single LNBF, the receiver tuner whose DP21 switch is connected to the passing side of the splitter must be plugged into a live power outlet at all times. If not, the DISH Pro single LNBF will not have any power and will not be able to provide satellite signal to the other receiver tuner.

When you set up your system following this diagram and run **Check Switch** the **Installation Summary** screen should look similar to the one shown below.

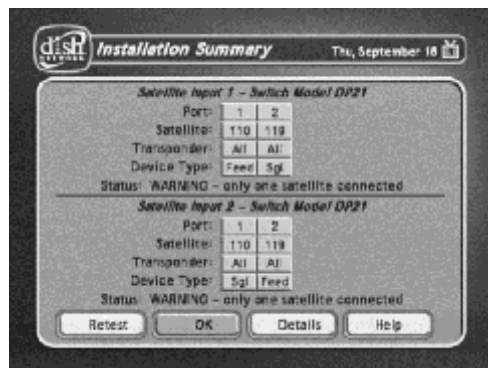

Running Coaxial Cable

1. Using the shortest path possible, run the coaxial cable(s) from the ground block or switch to the satellite receiver(s). Do *not* kink or pinch any cable. Cables should be bent *only* in gentle curves.



Do *not* use a longer cable between the satellite dish and the receiver than is specified in the DISH Pro or Legacy system installation instructions. If your system requires more cable than the limit specified in these installation instructions, you should consider having the system professionally installed.

2. Put a drip loop in each cable at a point before it enters the building. A drip loop allows moisture to drip from the cable before it runs into the building.

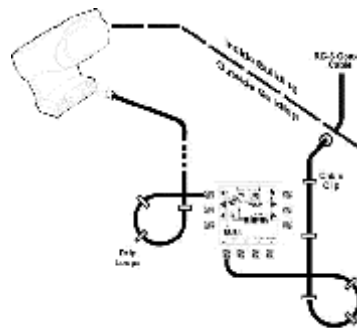

FOR EXAMPLE ONLY



Before drilling any holes in the wall or roof of your building, make sure that there are no wires or pipes in the area of the holes. If you are not comfortable doing this, contact a professional in your area. Make sure that you follow all safety instructions and building codes.

3. Locate each receiver inside the building, against or near an outside wall. Then drill a hole through the outer wall to pass a cable inside the building. If a receiver is located in an interior room, run a cable through the outside wall, and into an attic, basement, or crawl space in order to reach the receiver.
4. Seal all holes that you drill in the building with silicone or other weather-proof sealant after installation. Once each cable is inside the building, you may attach it to a wall receptacle or directly to a receiver.



Tighten the back panel coaxial cable connections *only* by hand. Using a wrench may over-tighten the connections, causing damage. Such damage is *not* covered by the Limited Warranty in the *User Guide* that came with the system.